

DER GUTE TON
 DIPL.-ING. MICHAEL HENKEMEIER
 AUDIO-ELEKTRONIK-SERVICE
 KÖRTESTR. 10, TEL./FAX 694 41 54

STEREO POWER AMP

M-40

SERVICE MANUAL

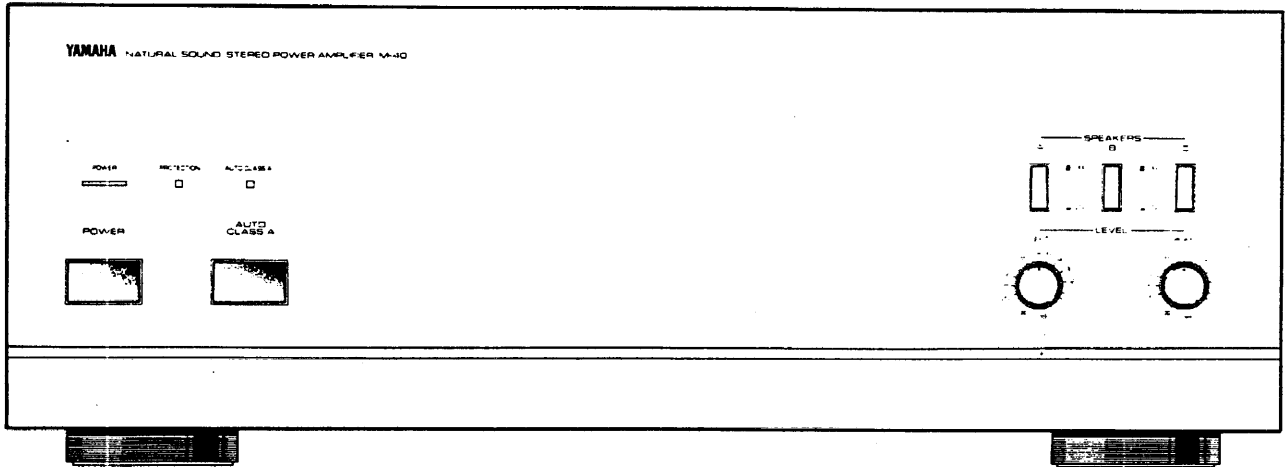

FRONT PANEL

TO SERVICE PERSONNEL

1. Critical Components Information.

Components having special characteristics are marked \triangle and must be replaced with parts having specifications equal to those originally installed.

2. Leakage Current Measurement (For 120V Model Only).

When service has been completed, it is imperative that you verify that all exposed conductive surfaces are properly insulated from supply circuits.

- Meter impedance should be equivalent to 1500 ohm shunted by 0.15 μ F.
- Leakage current must not exceed 0.5mA.
- Be sure to test for leakage with the AC plug in both polarities.

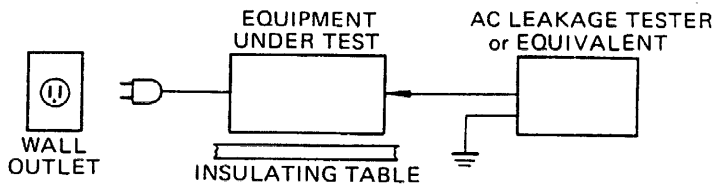

CONTENTS

REAR PANEL	1	PRINTED CIRCUIT BOARD	6, 7
DISASSEMBLY PROCEDURES	2	SCHEMATIC DIAGRAM	8
INTERNAL VIEW	3	PARTS LIST (ELECTRICAL PARTS)	10, 11
ADJUSTMENT	3	EXPLODED VIEW	12
SPECIFICATIONS/BLOCK DIAGRAM	4	PARTS LIST (MECHANISM PARTS)	13, 14
WIRING DIAGRAM	5		

004559

SINCE 1887



YAMAHA

NIPPON GAKKI CO., LTD. HAMAMATSU, JAPAN

2.6k-841 Printed in Japan. '84.6

DISASSEMBLY PROCEDURES

Step	Item	Work
1	Top Cover	1. Remove 4 screws ①. 2. Remove 2 screws ②.
2	Front Panel	Remove 5 screws ③.
3	Bottom Cover	Remove screws ④.
4	Main Circuit Board with Heat Sinks	1. Remove 4 screws ⑤. 2. Remove 6 screws ⑥. 3. Remove 2 screws ⑦.
5	Rear Panel	Remove 12 screws ⑧.

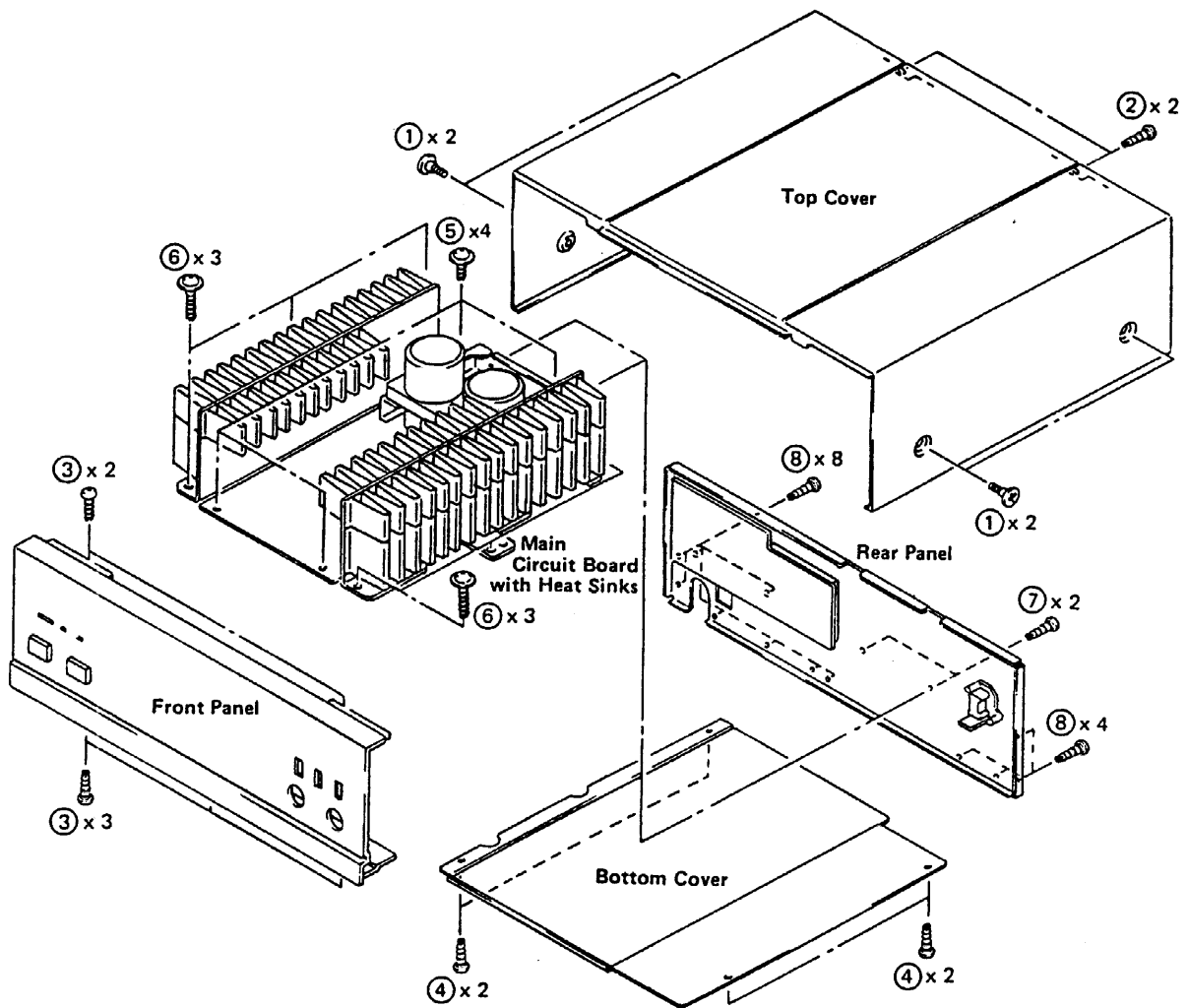

INTERNAL VIEW

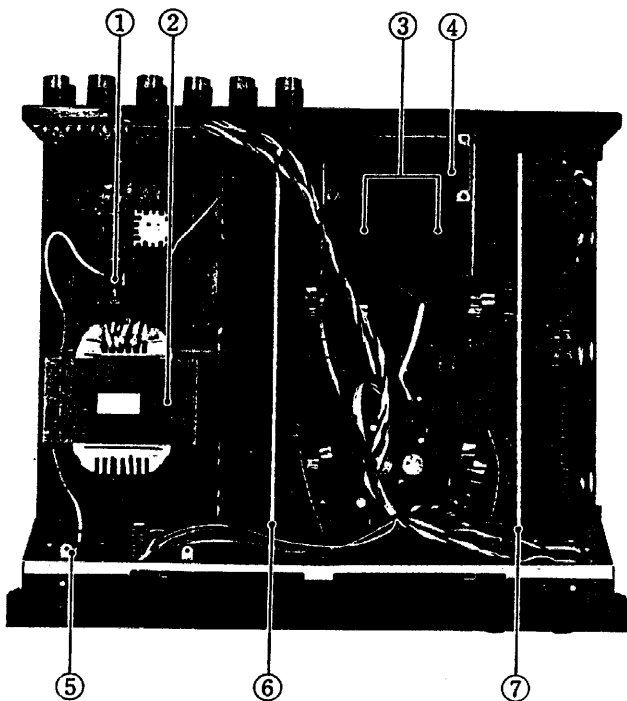

- ① FUSE
- ② POWER TRANSFORMER
 U.S.A. model : GA67680
 Canadian model : GA67690
 Australian and European model : GA67700
 General model : GA67720
- ③ ELECTROLYTIC CAPACITOR
 22000 μ F 69V : FZ00625
- ④ MAIN CIRCUIT BOARD
- ⑤ POWER SWITCH
- ⑥ HEAT SINK (L)
- ⑦ HEAT SINK (R)

ADJUSTMENT

● IDLING CURRENT adjustment

When replacing the power and drive transistors, adjust idling current. After the power has been turned on, age about 2 minutes in non loaded condition. Set Auto class A switch of OFF position.

Adjust VR103(Lch) and VR104(Rch) so that the voltage between TP1 and TP2(Lch), TP3 and TP4(Rch) comes to 10.0mV \pm 1mV, DC.

● AUTO CLASS A OPERATION confirmation

Make sure that when Auto Class A switch is pressed, the above-mentioned test point's voltage increases to 77mV \pm 8mV. (Idling Current 0.35A)

	Test points	Adjustment points	Rating
Lch	TP1 TP2	VR103	10.0 \pm 1mV
Rch	TP3 TP4	VR104	10.0 \pm 1mV

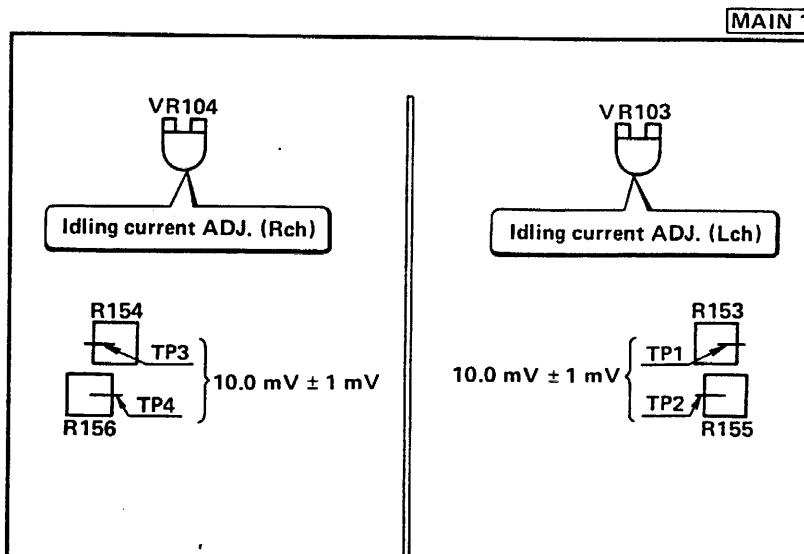

SPECIFICATIONS

Continuous Power Per Channel

20Hz – 20kHz 0.003% THD8Ω120W
 (class A10W)
 0.007% THD6Ω145W
 0.02% THD4Ω170W (U, C)
 175W (R)

Dynamic Power

1kHz 8Ω/6Ω/4Ω/2Ω160W/200W/280W/390W

DIN Standard Output Power Per Channel

1kHz 1%/10% THD4Ω 205W/230W (A, E)

Dynamic Headroom

8Ω1.25dB (R, U, C)
 4Ω2.16dB (R, U, C)

Power Bandwidth

0.03% THD 60W 8Ω 10Hz – 100kHz

Damping Factor

Speaker A 1kHz 8Ω 130

Input Sensitivity/Impedance (MAIN IN) . . . 1.07V/20kΩ

Frequency Response (20Hz – 20kHz) +0, -0.1dB

Total Harmonic Distortion

MAIN IN to SP out 60W/8Ω 0.002%

Intermodulation Distortion

AUX/TAPE/TUNER Rated Output/8Ω 0.003%

Signal to Noise Ratio (IHF-A-Network)

MAIN IN Shorted/5.1kΩ . . .127dB/119dB (R, U, C)

Residual Noise (IHF-A-Network)16μV (R, U, C)

Channel Separation (Input Shorted)

40Hz106dB
 1kHz 89dB
 10kHz 70dB

Power Supply

U.S. & Canadian ModelsAC120V, 60Hz
 General Model . . . AC110/120/220/240V, 50/60Hz
 European ModelAC220/240V, 50Hz
 Australian ModelAC240V, 50Hz

Power Consumption

U.S. & General Models 500W
 Canadian Model 660VA/500W
 European & Australian Models 650W

AC Outlet (unswitched)200W max (U, C, R)

Dimensions (W x H x D)435 x 165 x 425mm
 (17-1/8" x 6-1/2" x 16-3/4")

Weight14kg
 (30 lbs, 13 oz)

Specifications subject to change without notice.

MARKET

- U: U.S. Model
- C: Canadian Model
- R: General Model
- E: European Model
- A: Australian Model

BLOCK DIAGRAM

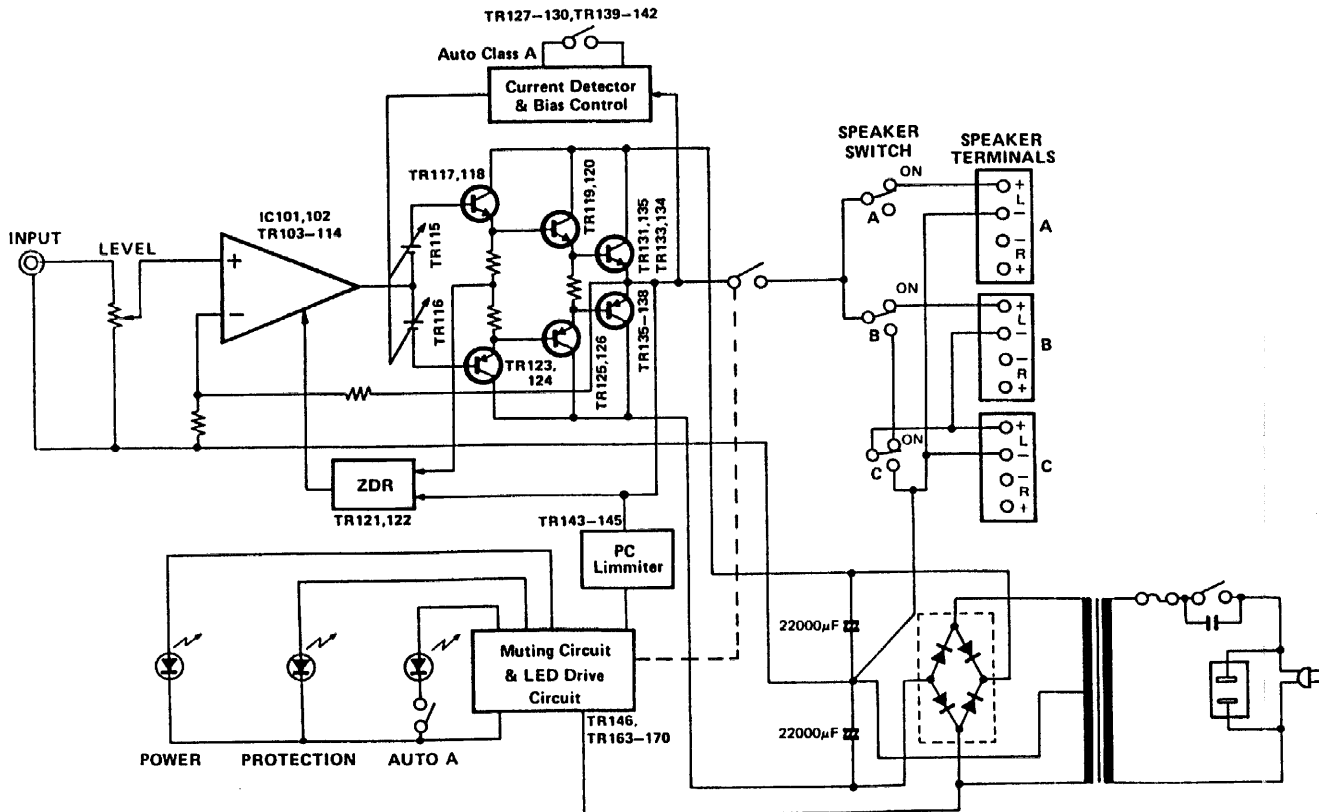

A

B

C

D

M-40

M

PRINTED CIRCUIT BOARD (Pattern Side)

MAIN 1

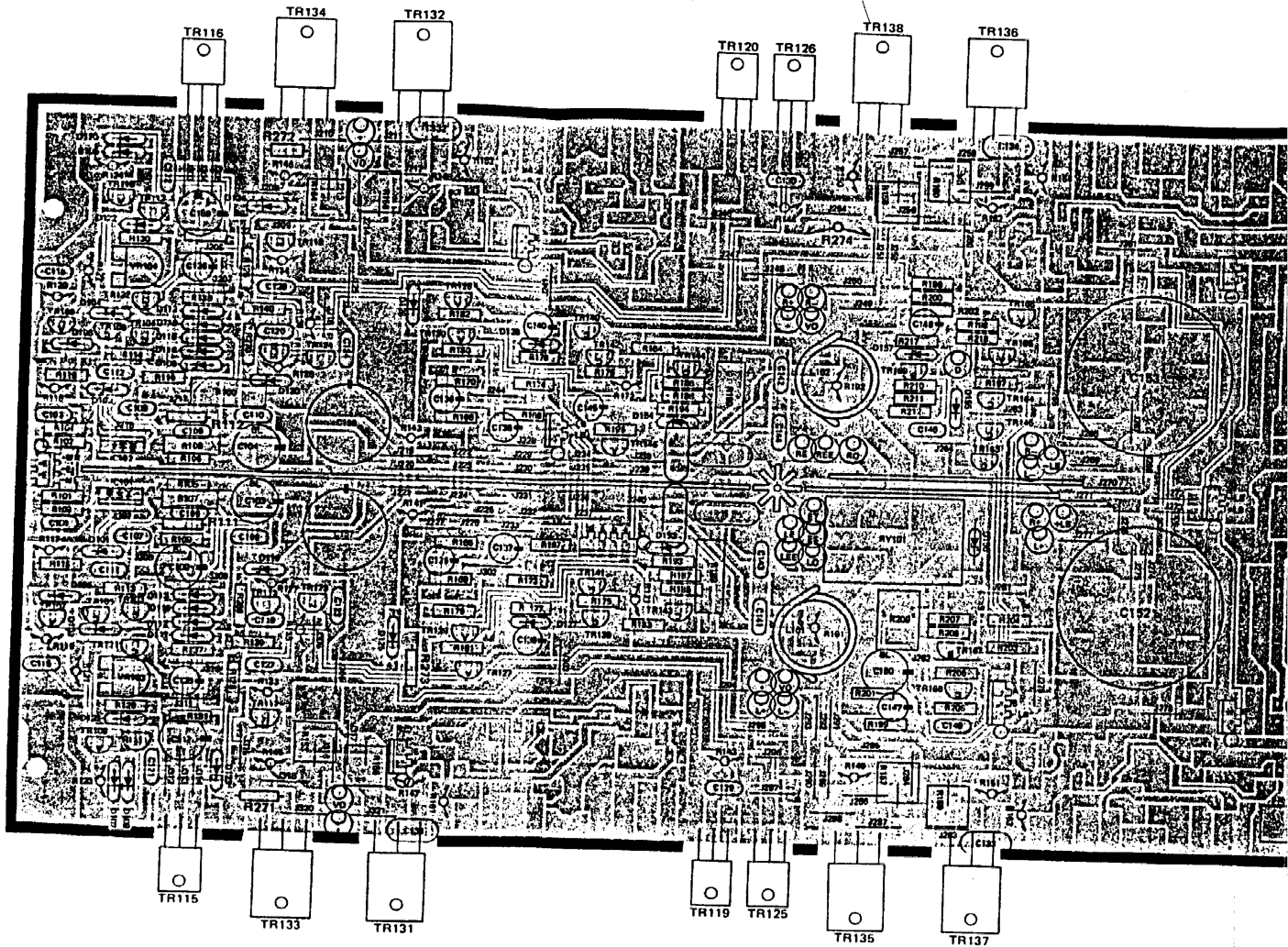

MAIN 2

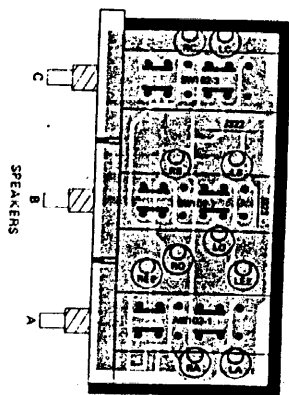

MAIN 3

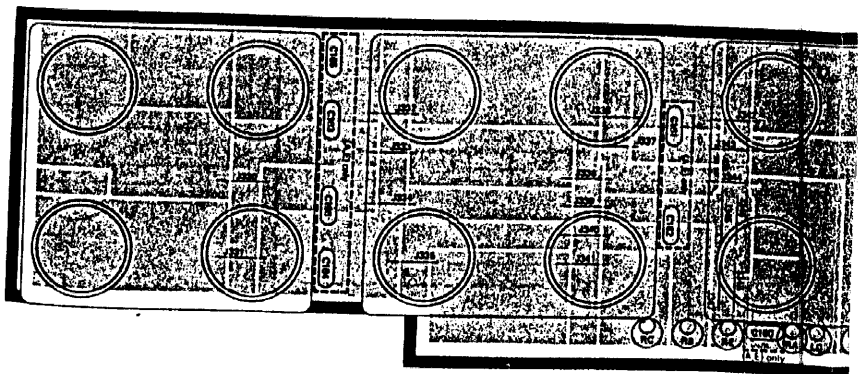

MAIN 4

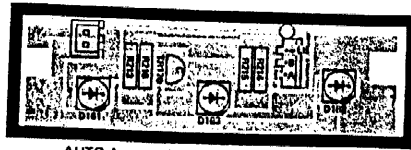

MAIN 6

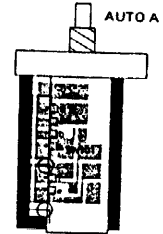

MAIN 5

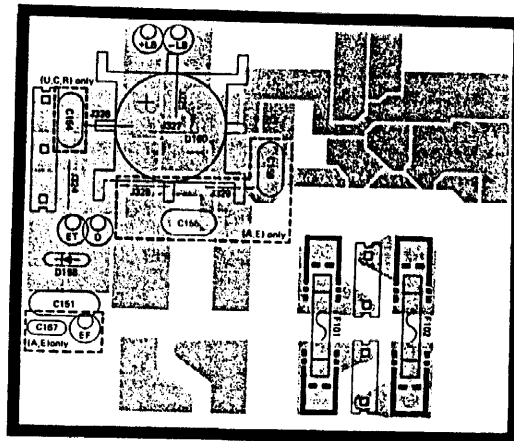

(R)

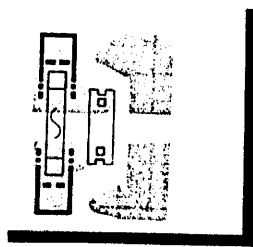

(U, C)

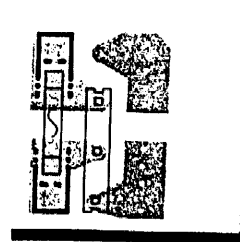

(A, E)

MAIN 7

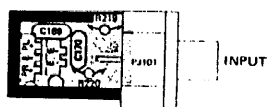

MAIN 8

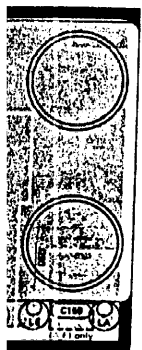
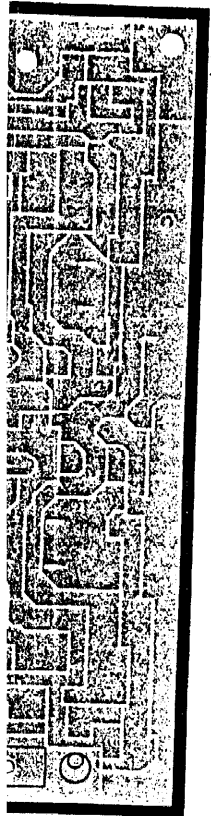
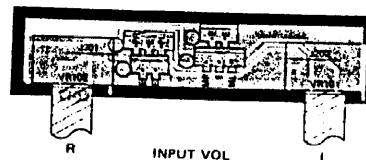

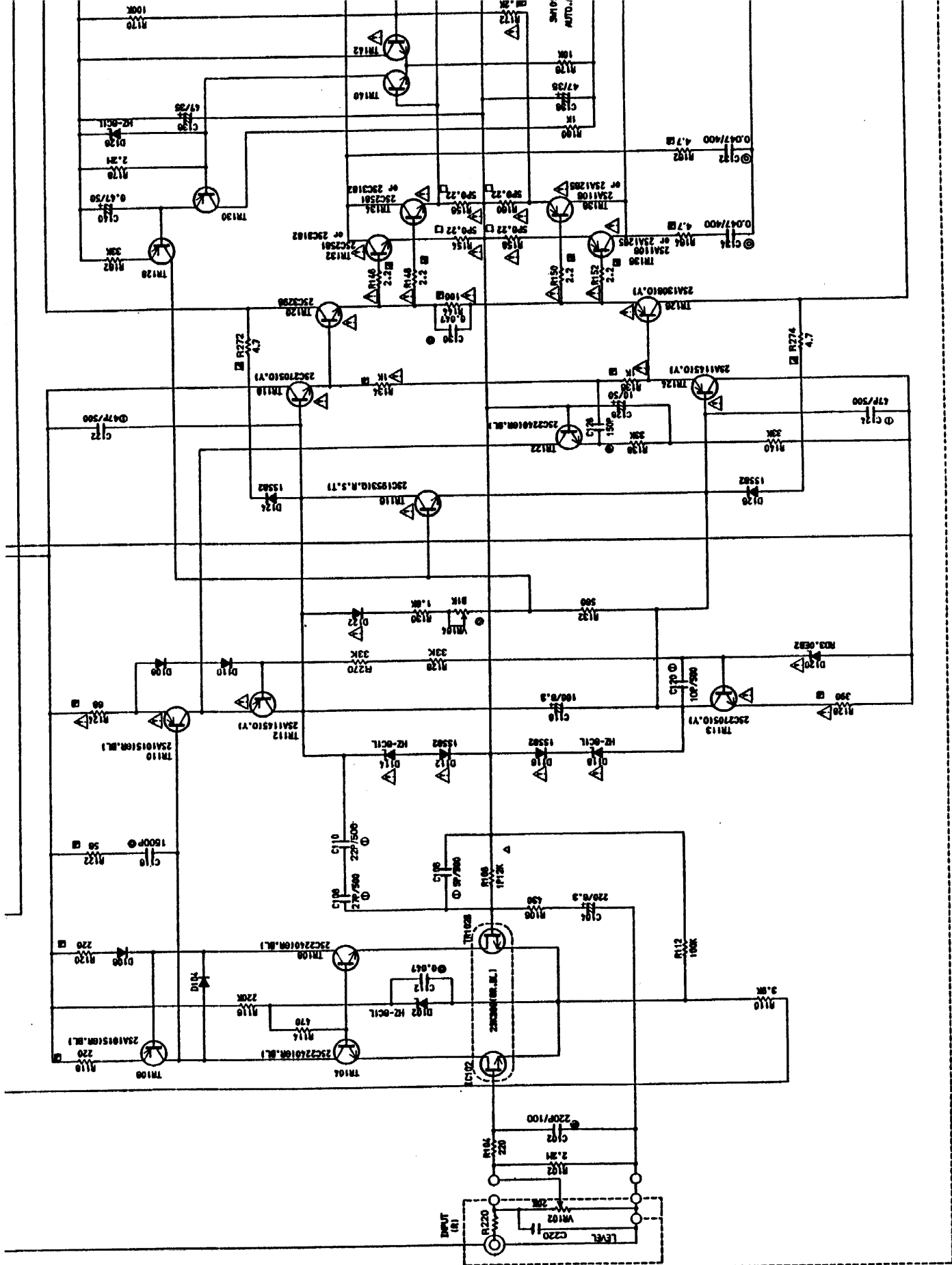

5

9

7

8

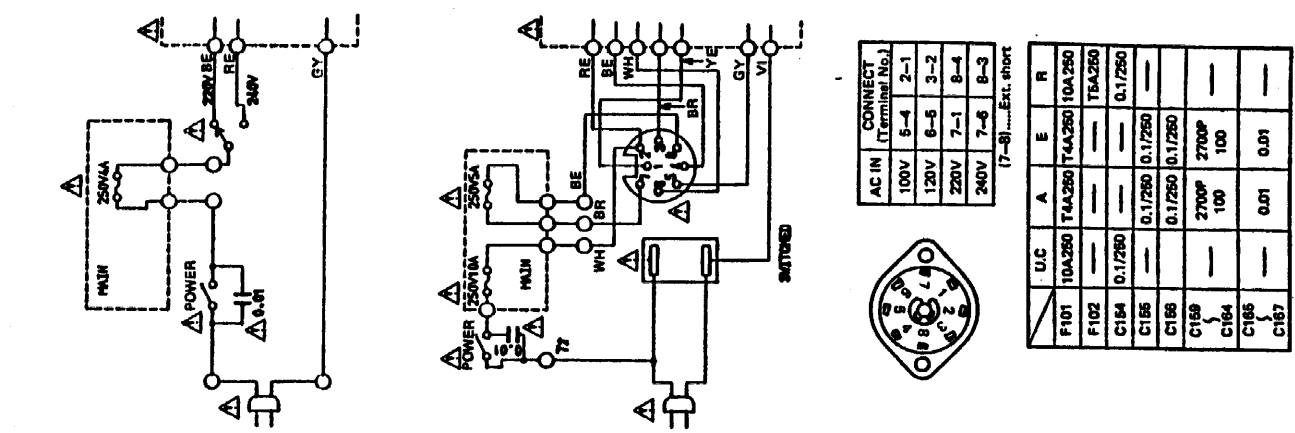

AC IN	CONNECT (Terminal No.)
100V	5-4 2-1
120V	6-5 3-2
220V	7-1 8-4
240V	7-6 8-3

(7-8).....Ext. short



U.C	A	E	R
F101	10A250	T4A250	10A250
F102	—	—	T6A250
C184	0.1/250	—	0.1/250
C185	—	0.1/250	0.1/250
C186	—	0.1/250	0.1/250
C189	2700P	2700P	—
C184	100	100	—
C185	—	0.01	0.01
C187	—	—	—

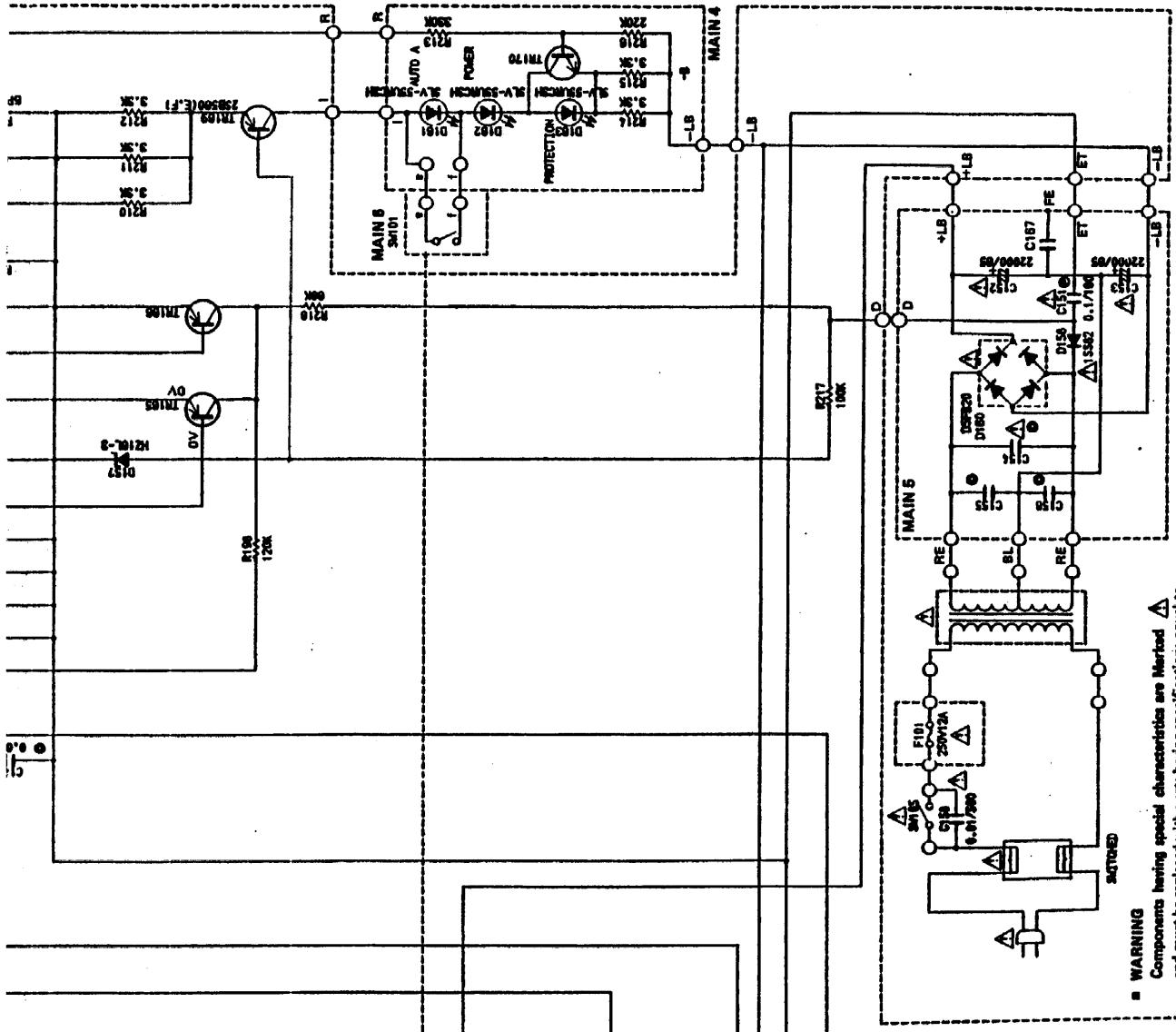

WARNING
 Components having special characteristics are Merfoid and must be replaced with parts having specifications equal to those originally installed.

• All voltage are measured with a 10MΩ/V DC electric volt meter.
 • Schematic diagram is subject to change without notice.

■ PARTS LIST (ELECTRICAL PARTS)

■ WARNING

Components having special characteristics are marked Δ and must be replaced with parts having specifications equal to those originally installed.

- Carbon resistors of this amplifier are 1/4W. There is no description about them in this parts list. Use the "Part No." HJ350000 or equivalent.

Ref. No.	Part No.	Description	品名	Remarks	ランク
	NA 084510	Main Circuit Board	メインシート	(U,C)	
	NA 084520	Main Circuit Board	メインシート	(R)	
	NA 084530	Main Circuit Board	メインシート	(A,E)	
	FC 363100	Mylar Capacitor	マイラーコン	C149	
	FA 413150	Mylar Capacitor	マイラーコン	C115,116	
	FC 364100	Mylar Capacitor	マイラーコン	C165-167 (A,E)	
	FC 364470	Mylar Capacitor	マイラーコン	C111,112,129,130,146	
	UT 452150	Polypropylene Capacitor	ポリプロコン	C127,128	
	UT 452220	Polypropylene Capacitor	ポリプロコン	C101,102	
	UT 452390	Polypropylene Capacitor	ポリプロコン	C169,170	
	FT 853270	Polypropylene Capacitor	ポリプロコン	C159-164(A,E)	
	FU 350500	Mica Capacitor	マイカコン	C105,106	
	FU 351100	Mica Capacitor	マイカコン	C119,120	
	FU 351220	Mica Capacitor	マイカコン	C109,110	
	FU 351470	Mica Capacitor	マイカコン	C121-124	
	FU 351270	Mica Capacitor	マイカコン	C107,108	
	FZ 005410	Electrolytic Capacitor	ブラックゲート(F)コン	C117,118,150	
	FZ 006130	Electrolytic Capacitor	ブラックゲート(F)コン	C103,104	
	FZ 006140	Electrolytic Capacitor	ブラックゲート(F)コン	C100	
	FZ 006040	Electrolytic Capacitor	ブラックゲート(F)コン	C157,158	
	FZ 004660	Metalized Mylar Capacitor	メタライズドマイラーコン	C154(R,U,C)	Δ
	FZ 004660	Metalized Mylar Capacitor	メタライズドマイラーコン	C155,156(A,E)	
	FZ 004660	Metalized Mylar Capacitor	メタライズドマイラーコン	C151	Δ
	FZ 000670	Metalized Mylar Capacitor	メタライズドマイラーコン	C131-134	
	UW 937100	Electrolytic Capacitor	ケミコン(自立形)	C145	
	UW 957100	Electrolytic Capacitor	ケミコン(自立形)	C147,148	
	UW 957470	Electrolytic Capacitor	ケミコン(自立形)	C135-138	
	UW 965470	Electrolytic Capacitor	ケミコン(自立形)	C139,140	
	UW 967100	Electrolytic Capacitor	ケミコン(自立形)	C125,126	
	FC 365100	Mylar Capacitor	マイラーコン	C141-144	
	GD 900520	Output Coil	アウトプットコイル	L101,102	
	HL 317120	Metal Oxide Film Resistor	酸金抵抗	R107,108	
	HL 323470	Metal Oxide Film Resistor	酸金抵抗	R189,190	
	HL 426330	Metal Oxide Film Resistor	酸金抵抗	R100	
	HZ 003880	Cement Resistor	セメント抵抗	R209	
	HZ 004470	Cement Resistor (Non-inductive)	セメント抵抗(無誘導)	R153-160	Δ
	HS 412350	Variable Resistor	V R	VR101,102	
	HT 370010	Semi Variable Resistor	半固定抵抗	VR103,104 } Inter-	
	HT 770030	Semi Variable Resistor	半固定抵抗	VR103,104 } Changeable	
	HV 553220	Flame Proof Cabon Resistor	不燃化カーボン抵抗	R145-152	Δ
	HV 553470	Flame Proof Cabon Resistor	不燃化カーボン抵抗	R161-164, 271-274	
	HV 554100	Flame Proof Cabon Resistor	不燃化カーボン抵抗	R191,192	
	HV 554470	Flame Proof Cabon Resistor	不燃化カーボン抵抗	R141,142	Δ
	HV 554560	Flame Proof Cabon Resistor	不燃化カーボン抵抗	R121,122	Δ
	HV 454680	Flame Proof Cabon Resistor	不燃化カーボン抵抗	R123,124	Δ
	HV 555100	Flame Proof Cabon Resistor	不燃化カーボン抵抗	R143,144	Δ
	HV 555220	Flame Proof Cabon Resistor	不燃化カーボン抵抗	R117-120	Δ
	HV 555390	Flame Proof Cabon Resistor	不燃化カーボン抵抗	R127,128	Δ
	HV 555560	Flame Proof Cabon Resistor	不燃化カーボン抵抗	R219,220	Δ

* : New Parts

ランク : Japan only

Ref. No.	Part No.	Description		品名	Remarks	ランク
	HV 556100	Flame Proof Carbon Resistor	1kΩ ERD-25FV	不燃化カーボン抵抗	R133-136	
	HV 556120	Flame Proof Carbon Resistor	1.2kΩ ERD-25FV	不燃化カーボン抵抗	R171,172	
	i A 097000	Transistor	2SA970(GR,BL)	トランジスター	TR145	
	i A 101570	Transistor	2SA1015(O,Y)	トランジスター	TR107-110	
	i A 111510	Transistor	Inter-Changeable { 2SA1115(E,F)	トランジスター	TR127-130,165,166	
	i A 112700	Transistor		2SA1127(R,S,T)		トランジスター
	i A 114500	Transistor	2SA1145(O,Y)	トランジスター	TR111,112,123,124	
	i B 056000	Transistor	2SB560(E,F)	トランジスター	TR167,169	
	i C 224000	Transistor	2SC2240(GR,BL)	トランジスター	TR103-106,121,122,143,144	
	i C 260310	Transistor	Inter-Changeable { 2SC2603(E,F)	トランジスター	TR139-142,146,163,164,168,	
	i C 263400	Transistor		2SC2634(R,S,T)		トランジスター
	i C 270500	Transistor	2SC2705(O,Y)	トランジスター	TR113,114,117,118	
	i E 104500	Dual FET	2SK389(GR,BL)	デュアル F E T	IC101,102	
	i F 000040	Diode	Inter-Changeable { 1S1555	ダイオード	D103-112,115,116,121,122,	
	i F 000670	Diode		1S2473		ダイオード
	i F 001400	Diode	1SS82	ダイオード	D123-126,153,154,158	
	i F 001510	Zener Diode	HZ-6C1L	ツェナーダイオード	D101,102,113,114,117,118,	
					127,128	
	i F 001840	Zener Diode	RD3.0EB2	ツェナーダイオード	D119,120	
	i F 001940	Zener Diode	SHZ2402	ツェナーダイオード	D156	
	i F 002080	Zener Diode	HZ16-3L	ツェナーダイオード	D100,157	
	i F 004440	LED (RED)	SLV-56URC3H	L E D	D161-163	
	i H 001130	Diode Bridge	D5FB20	ブリッジダイオード	D160	
	KA 804630	Push Switch		プッシュスイッチ	SW101	
	KA 804620	Push Switch	3 Circuit 3 Point	プッシュスイッチ	SW102	
	KB 000400	Fuse	T5A 250V	ヒ ユ - ズ	F102(R)	
	KB 000790	Fuse	T4A 250V	ヒ ユ - ズ	F101(A,E)	
	KB 001390	Fuse	Inter-Changeable { 10A 250V	ヒ ユ - ズ	F101(U,C)	
	KB 001490	Fuse		10A 250V		ヒ ユ - ズ
	KC 001150	Relay	JC2aD DC24V	リ レ -	RY101(U,C)	
	KC 001610	Relay	JC2aD DC24V	リ レ -	RY101(R,A,E)	
	LB 201830	2 Pin Jack		2 ピンジャック	PJ101	
	LA 005340	4P Speaker Terminal		4Pスピーカー端子板		
	LA 005370	6P Speaker Terminal		6Pスピーカー端子板	(A,E)	
	LB 201060	Fuse Holder Pin	YSH403T	ヒューズホルダーピン	(A,E)	
	LB 201970	Fuse Holder Pin		ヒューズホルダーピン	(R,U,C)	
	LA 002140	Wrapping Terminal I-type	2P P=10	I型ラッピング端子板	(R,U,C)	
	LA 002150	Wrapping Terminal I-type	3P P=10	I型ラッピング端子板		
	LB 918020	XH Base Pin I-type	2P	XHベースピン型フォーミング		
	BB 070430	Bus Bar	l=145	バスバ -		
	BB 070410	Bus Bar	l=55	バスバ -		
	BB 068370	Lug, Earth		アース金具		
	BB 070700	Lug, Earth		アース金具		

• : New Parts

ランク : Japan only

PARTS LIST (MECHANISM PARTS)

Ref. No.	Part No.	Description	品名	Remarks	ランク
1	NB 620700	Panel Unit			
1-1	AA 622080	Spring	M-80		
1-2	CB 630730	Button Frame			
1-3	CB 630350	Push Button	M-80		
1-4	CB 630360	Push Button Frame	M-80		
2	KA 803520	Push Switch	SDL TV-5		
3	CB 069250	Binding Tie	BK-1		
4	CB 095260	Cover for Capacitor	SB-0833		
5	F i 384100	Ceramic Capacitor	VA-1 0.01 μ F/500V		
6	GA 676800	Power Transformer			
6	GA 676900	Power Transformer			
6	GA 677000	Power Transformer			
6	GA 677200	Power Transformer			
7	LB 201480	Voltage Selector			
8	CB 620190	Cord Stopper	CM-22B		
8	CB 620200	Cord Stopper	CM-22C		
9	KA 401260	Slide Switch	SS-12 5A/40A		
10	LA 002950	Terminal Plate	2P MA0092A		
11	LB 201810	AC Outlet			
12	MG 000920	Power Cord	7.5A/250V 2.5m		
12	MG 001490	Power Cord	7.5A/250V 2.5m		
12	MG 000960	Power Cord	2.5A/250V 2m		
12	MG 001620	Power Cord	2.5A/250V 2m		
12	MG 001450	Power Cord	10A/125V 1.98m		
12	MG 001460	Power Cord	10A/125V 2m		
12	MG 001630	Power Cord	2.5A/250V 2m		
13	AA 622000	Side Frame (L)			
14	CB 630740	Holder, Circuit Board			
15	CB 068880	Plastic Rivet			
16	i A 110600	Transistor	2SA1106		
17	i C 258100	Transistor	2SC2581		
16	i X 603240	Transistor	2SA1265		
17	i X 603250	Transistor	2SC3182		
18	i A 130610	Transistor	2SA1306		
19	i C 329810	Transistor	2SC3298		
20	i C 195350	Transistor	2SC1953(Q,R,S,T)		
21	BA 090050	Heat Sink (L)			
22	BA 090060	Heat Sink (R)			
23	i L 000460	Mica Base	AC-238		
24	NA 084510	Main Circuit Board			
24	NA 084520	Main Circuit Board			
24	NA 084530	Main Circuit Board			
25	FZ 006250	Electrolytic Cap. Set	22000 μ F/69V		
26	CB 099580	Cover, Fuse			
27	AA 621980	Top Cover	M-80		
28	AA 622030	Bottom Cover	M-80		

* : New Parts

ランク : Japan only

Ref. No.	Part No.	Description	品名	Remarks	ランク
29	AA 622040	Stay, Heat Sink	M-80	ヒートシンクステー	
30	AA 622090	Stay, Electrolytic Cap.	M-60	ケミコンステー	
31	AA 622370	Rear Panel		リアパネル (R)	
31	AA 622380	Rear Panel		リアパネル (U,C)	
31	AA 622390	Rear Panel		リアパネル (A)	
31	AA 622400	Rear Panel		リアパネル (E)	
32	NB 620320	Leg Ass'y	M-80	脚 Ass'y	
33	NB 620460	Button Ass'y	M-80	ボタン Ass'y	
34	BA 085870	Knob	A-05	ノブ	
35	CB 601440	VS Stopper	A-6	V S ストッパー	(E)
36	CB 630370	Side Plate (L)	M-80	サイドプレート(L)	
37	CB 630380	Side Plate (R)	M-80	サイドプレート(R)	
38	CB 630760	Damper	M-80	ダンパー	
39	CB 601340	Spacer	T-6	スペーサー	
40	ED 330066	Bind Head Screw	M3x6 FCM3-BL	バインド小ネジ	PACK
41	E i 330086	Bind Head Screw (B-type)	M3x8 FCM3-BL	バインドタップタイト(Bタイト)	PACK
42	EK 365080	B.W. Head Screw	M3x8 φ10 FCM3-BL	B W ヘッドネジ	
43	EK 330030	B.W. Head Screw	M3x10 φ8 FCM3-BL	B W ヘッドネジ	
44	EA 330186	Pan Head Screw	M3x18 ZMC2-BL	ナベ小ネジ	PACK
45	E i 340106	B.W. Head Screw	M4x10 FCM3-BL	バインドタッピングネジ	
46	EB 340106	Flat Head Screw (S-type)	M4x10 FCM3-BL	皿小ネジ(Sタイト)	PACK
47	AX 600150	Screw (S-type)	M4x8 FCM3-BL	化粧ネジ(Sタイト)	
48	EZ 001400	Ground Terminal Screw	M3x13.5 MFNi-II	アース端子ネジ	
49	EZ 001350	Cap Screw	M3x14 φ8 FCM3-BL	カップネジ(Bタイト)	
50	EV 901360	Sens Plain Washer	φ10xφ3.6x0.8	セムス平座金	FNM3-3g
51	EV 203106	Plain Washer	φ10	平座金	
52	EV 203036	Plain Washer	φ3 FCRM-3BL	平座金	

* : New Parts

ランク : Japan only

M-40